

Designer Deletion Strains derived from *Saccharomyces cerevisiae* S288C: a Useful set of Strains and Plasmids for PCR-mediated Gene Disruption and Other Applications

CARRIE BAKER BRACHMANN, ADRIAN DAVIES, GREGORY J. COST, EMERITA CAPUTO, JOACHIM LI†, PHILIP HIETER AND JEF D. BOEKE*

Department of Molecular Biology and Genetics, Johns Hopkins University School of Medicine, Baltimore, MD 21205, U.S.A.

Received 9 June 1997; accepted 18 June 1997

A set of yeast strains based on *Saccharomyces cerevisiae* S288C in which commonly used selectable marker genes are deleted by design based on the yeast genome sequence has been constructed and analysed. These strains minimize or eliminate the homology to the corresponding marker genes in commonly used vectors without significantly affecting adjacent gene expression. Because the homology between commonly used auxotrophic marker gene segments and genomic sequences has been largely or completely abolished, these strains will also reduce plasmid integration events which can interfere with a wide variety of molecular genetic applications. We also report the construction of new members of the pRS400 series of vectors, containing the *kanMX*, *ADE2* and *MET15* genes. © 1998 John Wiley & Sons, Ltd.

Yeast 14: 115–132, 1998.

KEY WORDS — *Saccharomyces cerevisiae*; yeast; gene disruption; S288C; bacteria-yeast shuttle vectors; auxotrophic markers

INTRODUCTION

Deletion mutations are valuable because they never revert. This is particularly true with regard to DNA transformation because there is no background of revertants to sort through; any organism that acquires the wild-type phenotype is by definition a transformant. A problem with most deletion alleles is that they rarely precisely affect a single gene; there may be 'collateral' effects on one or more adjacent genes that can confound genetic analysis. The availability of whole-genome sequence information together with modern

recombinant technologies like the polymerase chain reaction (PCR) allows the precise design of deletions that are much less likely to have such problems. We have designed a strategy exploiting these technologies to create a set of precise deletion alleles of commonly used auxotrophic markers in the yeast *Saccharomyces cerevisiae*. As additional complete genomes are sequenced, this strategy can be used to create high quality deletion alleles in other organisms.

Traditionally the yeast *S. cerevisiae* has served as one of the best genetically tractable eukaryotic systems. Researchers have for years been able to disrupt genes in yeast in order to study their mutant phenotypes; however, the techniques used for gene disruption have had limitations. First, the gene to be disrupted had to be cloned. Second, because available restriction sites were used to delete a portion of the gene and insert a selectable marker, 5' or 3' fragments of the gene were often

*Correspondence to: J. D. Boeke, Hunterian 617, Department of Molecular Biology and Genetics, Johns Hopkins University School of Medicine, 725 N. Wolfe Street, Baltimore, MD 21205, U.S.A. Tel: (+1) 410 955 2481; fax: (+1) 410 614 2987; e-mail: jef.boeke@gmail.bs.jhu.edu.

†Present address: Department of Biochemistry, University of California, San Francisco, CA, U.S.A.
Contract grant sponsor: NIH.

left in the genome, raising potential doubt about the null phenotype. A method has recently been developed that allows complete deletion of the gene of interest and its replacement with an auxotrophic marker gene (Baudin *et al.*, 1993; Lorenz *et al.*, 1995). This procedure, called PCR-mediated gene disruption, requires only knowledge of the genomic sequence of the gene of interest, allowing for precise gene deletion prior to its cloning and immediate study of the null phenotype. Along with the availability of the entire *S. cerevisiae* genomic sequence, the method of PCR-mediated gene disruption has changed the face of yeast genetics, enabling researchers to quickly assess a gene's possible function through evaluation of the null phenotype, and to efficiently tackle the more complex problems inherent in the analysis of multi-gene families.

Like its predecessor method, one-step gene disruption (Rothstein, 1983), PCR-mediated gene disruption relies on the fact that homologous recombination in yeast can be efficiently mediated by linear fragments of DNA. The method requires two ~60 nucleotide (nt) PCR primers; the 20 nts of sequence at the 3' ends of each primer is specific for the amplification of an auxotrophic marker gene, and the 40 nts of sequence at the 5' ends is identical to the left and right genomic sequence flanking the gene of interest. Using these targeting primers, the auxotrophic marker gene is amplified and the resulting PCR product contains the marker gene and 40 bp of genomic DNA sequence to the left and right of the gene deletion of interest. This product is then transformed into yeast, and stable transformants are selected on appropriate medium. These transformants include those cells in which two crossover events occurred, one between each end of the 40 bp target sequences of the PCR product and the corresponding genomic DNA sequence, thereby replacing the gene of interest with the auxotrophic marker gene.

A limitation of this method has been that the genomic alleles of many of the most commonly used auxotrophic markers are point mutations, small internal deletions, or Ty1 insertions, and therefore retain large regions of homology to the internal selectable marker segment of the PCR product. This results in a high background of positive transformants in which the marker gene has replaced the auxotrophic mutation by marker locus gene conversion, leaving the gene of interest unaffected. This problem is circumvented by use of the set of 'designer' deletion strains we have made,

in which some commonly used auxotrophic marker genes have been completely deleted. These strains eliminate the background of undesired marker gene convertants. Because the homology between commonly used auxotrophic marker gene segments and genomic sequences has been largely or completely abolished, these strains will also reduce plasmid integration events which can interfere with a wide variety of molecular genetic applications. We have also constructed a designer deletion allele of the *MET15* gene, a selectable marker gene which is useful both because it is counterselectable and because it can be used as a colony color marker (Cost and Boeke, 1996).

Additionally, we have increased the repertoire of the pRS plasmids by constructing new versions containing the *kanMX* marker (Wach *et al.*, 1994), *ADE2* and *MET15* markers. Finally, we have designed universal PCR primers for PCR-mediated gene disruption. This strategy allows the amplification of each of the auxotrophic marker genes found in the pRS set of plasmids (Sikorski and Hieter, 1989). Thus, the same primers can be used to amplify any of the auxotrophic marker genes, allowing for much greater flexibility in the design of gene knockout experiments.

MATERIALS AND METHODS

Strains and media

The yeast strains are all directly descended from FY2 (Winston *et al.*, 1995), which is itself a direct descendant of S288C, and are described in Table 1. The genealogy of the strains in this paper is summarized in Figure 1. Media used were as described (Boeke *et al.*, 1984; Rose *et al.*, 1990), or as described in Table 2 for scoring the *met15* marker. Efficient sporulation of diploids required growth as a patch on freshly poured GNA pre-sporulation plates (5% glucose, 3% Difco nutrient broth, 1% Difco yeast extract, 2% agar) for 1 day at 30°C prior to transfer to liquid sporulation medium (1% potassium acetate, 0.005% zinc acetate). Typically, a generous matchhead of cells was resuspended in 2 ml of liquid sporulation medium. Sporulation cultures were incubated on a roller wheel for 1 day at 25°C followed by 3–5 days at 30°C and could be readily dissected. In general, sporulation efficiencies were of the order of 20–30% (pre-growth of diploids on YPD instead of GNA resulted in somewhat lower sporulation efficiencies).

Table 1. Yeast strains.

Strain	ATCC number ^a	Genotype						
FY2		<i>MATα</i>						<i>ura3-52</i>
FY3		<i>MATα</i>						<i>ura3-52</i>
FY4		<i>MATα</i>						
FY5		<i>MATα</i>						
YCB436		<i>MATα</i>	<i>ade2Δ::hisG</i>	<i>his3Δ200</i>	<i>leu2Δ1</i>	<i>lys2Δ202</i>	<i>trp1Δ63</i>	<i>ura3-52</i>
BY378		<i>MATα</i>		<i>his3Δ200</i>				<i>ura3-52</i>
BY379		<i>MATα</i>		<i>his3Δ200</i>				
BY388		<i>MATα</i>	<i>ade2Δ::hisG</i>	<i>his3Δ200</i>			<i>trp1Δ63</i>	<i>ura3-52</i>
BY389		<i>MATα</i>	<i>ade2Δ::hisG</i>	<i>his3Δ200</i>			<i>trp1Δ63</i>	<i>ura3-52</i>
BY397		<i>MATα</i>	<i>ade2Δ::hisG</i>	<i>his3Δ200</i>			<i>trp1Δ63</i>	
BY398		<i>MATα</i>	<i>ade2Δ::hisG</i>	<i>his3Δ200</i>			<i>trp1Δ63</i>	
BY399		<i>MATα</i>	<i>ade2Δ::hisG</i>	<i>his3Δ200</i>			<i>trp1Δ63</i>	<i>ura3Δ0</i>
BY401		<i>MATα</i>	<i>ade2Δ::hisG</i>	<i>his3Δ200</i>			<i>trp1Δ63</i>	<i>ura3Δ0</i>
BY404		<i>MATα</i>	<i>ade2Δ::hisG</i>	<i>his3Δ200</i>	<i>leu2Δ0</i>		<i>trp1Δ63</i>	<i>ura3Δ0</i>
BY406		<i>MATα</i>	<i>ade2Δ::hisG</i>	<i>his3Δ200</i>		<i>lys2Δ0</i>	<i>trp1Δ63</i>	<i>ura3Δ0</i>
BY411		<i>MATα</i>	<i>ade2Δ::hisG</i>	<i>his3Δ200</i>		<i>lys2Δ0</i>	<i>met15Δ0</i>	<i>ura3Δ0</i>
BY413		<i>MATα</i>		<i>his3Δ200</i>		<i>lys2Δ0</i>	<i>met15Δ0</i>	
BY418		<i>MATα</i>	<i>ade2Δ::hisG</i>	<i>his3Δ200</i>	<i>leu2Δ0</i>	<i>lys2Δ0</i>	<i>met15Δ0</i>	<i>trp1Δ63</i>
BY4700	200866	<i>MATα</i>						<i>ura3Δ0</i>
BY4702	200867	<i>MATα</i>			<i>leu2Δ0</i>	<i>lys2Δ0</i>	<i>met15Δ0</i>	
BY4704	200868	<i>MATα</i>	<i>ade2Δ::hisG</i>	<i>his3Δ200</i>	<i>leu2Δ0</i>	<i>lys2Δ0</i>	<i>met15Δ0</i>	<i>trp1Δ63</i>
BY4705	200869	<i>MATα</i>	<i>ade2Δ::hisG</i>	<i>his3Δ200</i>	<i>leu2Δ0</i>	<i>lys2Δ0</i>	<i>met15Δ0</i>	<i>trp1Δ63</i>
BY4706	200870	<i>MATα</i>					<i>met15Δ0</i>	
BY4707	200871	<i>MATα</i>					<i>met15Δ0</i>	
BY4709	200872	<i>MATα</i>						<i>ura3Δ0</i>
BY4710	200873	<i>MATα</i>					<i>trp1Δ63</i>	
BY4711	200874	<i>MATα</i>					<i>trp1Δ63</i>	
BY4712	200875	<i>MATα</i>			<i>leu2Δ0</i>			
BY4713	200876	<i>MATα</i>			<i>leu2Δ0</i>			
BY4714	200877	<i>MATα</i>		<i>his3Δ200</i>				
BY4715	200878	<i>MATα</i>				<i>lys2Δ0</i>		
BY4716	200879	<i>MATα</i>				<i>lys2Δ0</i>		
BY4717	200880	<i>MATα</i>	<i>ade2Δ::hisG</i>					
BY4718	200881	<i>MATα</i>					<i>met15Δ0</i>	<i>ura3Δ0</i>
BY4719	200882	<i>MATα</i>					<i>trp1Δ63</i>	<i>ura3Δ0</i>
BY4720	200883	<i>MATα</i>				<i>lys2Δ0</i>	<i>trp1Δ63</i>	<i>ura3Δ0</i>
BY4722	200884	<i>MATα</i>			<i>leu2Δ0</i>			<i>ura3Δ0</i>
BY4723	200885	<i>MATα</i>		<i>his3Δ200</i>				<i>ura3Δ0</i>
BY4724	200886	<i>MATα</i>				<i>lys2Δ0</i>		<i>ura3Δ0</i>
BY4725	200887	<i>MATα</i>	<i>ade2Δ::hisG</i>					<i>ura3Δ0</i>
BY4726	200888	<i>MATα</i>	<i>ade2Δ::hisG</i>					<i>ura3Δ0</i>
BY4727	200889	<i>MATα</i>		<i>his3Δ200</i>	<i>leu2Δ0</i>	<i>lys2Δ0</i>	<i>met15Δ0</i>	<i>trp1Δ63</i>
BY4728	200890	<i>MATα</i>		<i>his3Δ200</i>				<i>trp1Δ63</i>
BY4729	200891	<i>MATα</i>		<i>his3Δ200</i>				<i>trp1Δ63</i>
BY4730	200892	<i>MATα</i>			<i>leu2Δ0</i>		<i>met15Δ0</i>	<i>ura3Δ0</i>
BY4731	200893	<i>MATα</i>			<i>leu2Δ0</i>		<i>met15Δ0</i>	<i>ura3Δ0</i>
BY4732	200894	<i>MATα</i>		<i>his3Δ200</i>			<i>met15Δ0</i>	<i>trp1Δ63</i>
BY4733	200895	<i>MATα</i>		<i>his3Δ200</i>	<i>leu2Δ0</i>		<i>met15Δ0</i>	<i>trp1Δ63</i>
BY4734	200896	<i>MATα</i>		<i>his3Δ200</i>	<i>leu2Δ0</i>		<i>met15Δ0</i>	<i>trp1Δ63</i>
BY4735	200897	<i>MATα</i>	<i>ade2Δ::hisG</i>	<i>his3Δ200</i>	<i>leu2Δ0</i>		<i>met15Δ0</i>	<i>trp1Δ63</i>
BY4736	200898	<i>MATα</i>	<i>ade2Δ::hisG</i>	<i>his3Δ200</i>			<i>met15Δ0</i>	<i>trp1Δ63</i>
BY4737	200899	<i>MATα</i>	<i>ade2Δ::hisG</i>	<i>his3Δ200</i>			<i>met15Δ0</i>	<i>trp1Δ63</i>
BY4738	200900	<i>MATα</i>						<i>trp1Δ63</i>
BY4739	200901	<i>MATα</i>			<i>leu2Δ0</i>	<i>lys2Δ0</i>		<i>ura3Δ0</i>
BY4740	200902	<i>MATα</i>			<i>leu2Δ0</i>	<i>lys2Δ0</i>		<i>ura3Δ0</i>
BY4741 ^b	201388	<i>MATα</i>		<i>his3Δ1</i>	<i>leu2Δ0</i>		<i>met15Δ0</i>	<i>ura3Δ0</i>
BY4742 ^b	201389	<i>MATα</i>		<i>his3Δ1</i>	<i>leu2Δ0</i>	<i>lys2Δ0</i>		<i>ura3Δ0</i>

Data in this table are maintained electronically at <http://www.welch.jhu.edu/~gregory/MET15.html>.

^aATCC, American Type Culture Collection, Rockville, MD.

^bStrains selected as parent strains for the international systematic *Saccharomyces cerevisiae* gene disruption project.

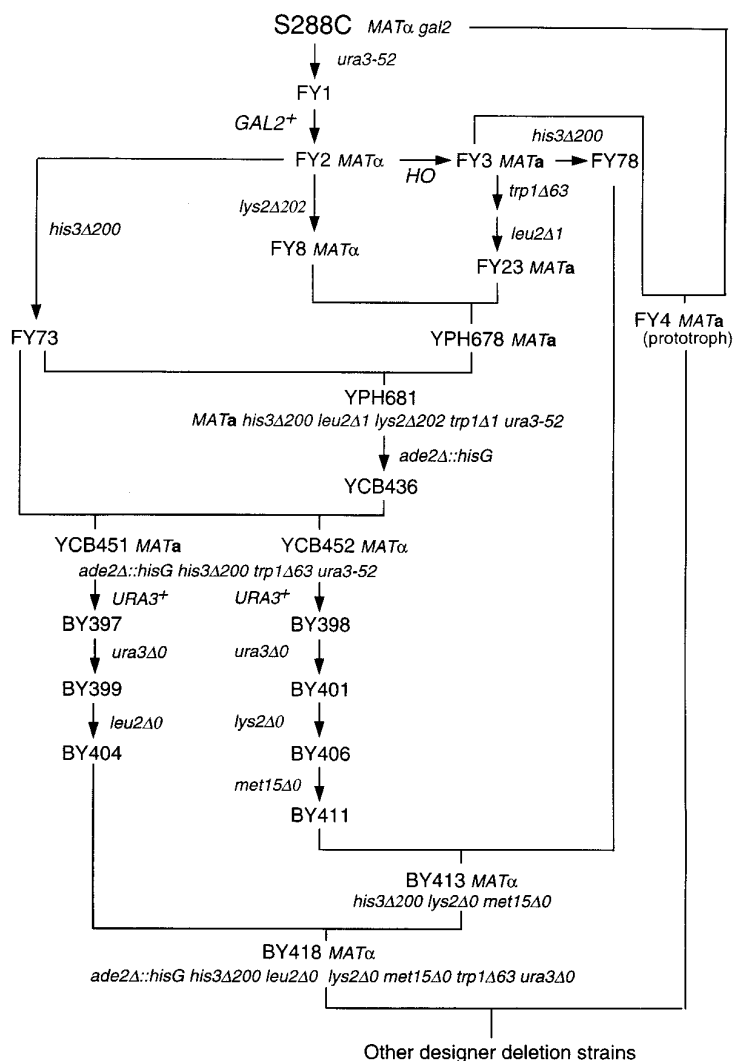

Figure 1. Genealogy of the designer deletion strains. A diagram presenting the lineage of the designer deletion strains and defining them as direct descendants of the original S288C isolate. Lines with arrows indicate that the identified allele was introduced by transformation. Lines connecting two strains define a mating between the two strains, and lines without arrows indicate that a spore from the mating was identified. In those instances where spores were identified, their genotypes are indicated. Further details of the genealogy are presented in Materials and Methods.

PCR of marker flanking sequences

Oligos LEU2-1 (cgggtaccACAGACTTTT ATACGTAC—small letters indicate restriction sites added) and LEU2-2 (cgcgatccGAGAACA TTCATGATTAGAGG) were used to amplify a 1010 bp region to the left of *LEU2* and oligos LEU2-3 (cgcgatccCGACACGAAATTACAAA ATG) and LEU2-4 (cgcgtggagctcCAAGTGTGTC

TTGGAAGCCG) were used to amplify a 1220 bp region to the right of *LEU2*. Oligos LYS2-1 (cgggtaccGTACTTTTTGAACCTTCGTC) and LYS2-2 (cgcgatccAGAAGCGGTCAGGAAGA AG AAA) were used to amplify a 917 bp region to the left of *LYS2* and oligos LYS2-3 (cgcgatccTC CATGTACAATAATTAATATGAATTAGG) and LYS2-4 (cgcgtggagctcCATCATGCTGCGA

Table 2. Medium used for scoring *met15*.

Lead plates ^a (per liter)
3 g peptone
5 g yeast extract
200 mg ammonium sulfate
20 g agar
q.s. 800 ml with water
Autoclave
1 g lead nitrate (add 2 ml 0.5 g/ml filter-sterilized stock after cooling above mixture to 55°C)
40 g glucose (add 200 ml 20% stock)

^aLead plates are useful because *met15* strains are dark brown to black, whereas wild-type strains are white. To score the Met⁻ auxotrophic phenotype, use SD plates supplemented with the requirements of the strain. Note that SC – met medium cannot be used unless cysteine is also omitted, as either methionine or cysteine allows growth of *met15* mutants (Ono *et al.*, 1991; Cost and Boeke, 1996).

AGAACTA) were used to amplify a 1178 bp region to the right of *LYS2*. Oligos MET15-1 (cggggtaccAAGTTCTCGTCGAATGCTAGG) and MET15-2 (cgcggatccTGCCAACCACCACAG TTCCCC) were used to amplify a 1034 bp region to the left of *MET15* and oligos MET15-3 (cgcggatccTCAGATATAGTCGGATTGCCC) and MET15-4 (cgcgtggagctcGGTGTGACACC TTCTCCGC) were used to amplify a 2084 bp region to the right of *MET15*. In all cases, the left fragment included a *KpnI* site at its 5' end and a

BamHI site at its 3' end, and the right fragment included a *BamHI* site at its 5' end and a *SacI* site at its 3' end.

Plasmids

pJL164 contains the *BglII*–*BamHI* genomic fragment containing *URA3* cloned into the *BamHI* and *XhoI* sites, respectively, of pRS305; the *URA3* ORF has been deleted from this construct by removing a 1.1 kb segment from *HindIII* to *SmaI*, leaving a *SmaI* linker at the deletion junction. pAD1 is pRS406 containing the left and right flanking fragments of *LEU2*. The left fragment was first digested with *KpnI* and *BamHI* and the right fragment was digested with *BamHI* and *SacI*. Both fragments were then purified and ligated into pRS406 linearized with *KpnI* and *SacI*. Correct 3 piece ligations were confirmed by restriction digestion. Plasmids pAD2 (pRS406 containing the left and right flanking fragments of *LYS2*) and pAD4 (pRS406 containing the left and right flanking fragments of *MET15*) were constructed in an identical manner. These plasmids are available from ATCC (Table 3).

New pRS plasmids

In these plasmids, the composition, orientation and position of insertion of the *CENARS* and 2 μ cassettes are identical to those described by Sikorski and Hieter (1989) and Christianson *et al.* (1992), respectively. Throughout pRS plasmid

Table 3. Description of Δ0 deleter plasmids.

Plasmid	ATCC number ^a	Resulting allele	Enzyme for linearization ^b	Selection(s) ^c
pAD1	87468	<i>leu2Δ0</i>	<i>SalI</i>	Ura ⁺ , Foa ^R
pAD2	87469	<i>lys2Δ0</i>	<i>ClaI</i>	Ura ⁺ , Foa ^R
pAD4	87470	<i>met15Δ0</i>	<i>ClaI</i>	Ura ⁺ , Foa ^R
pJL164	87471	<i>ura3Δ0</i>	<i>SpeI</i> , <i>XhoI</i>	One-step Foa ^R
<i>Other cloned deletions</i>				
YRp14- <i>his3Δ200</i>	77146	<i>his3Δ200</i>		Ura ⁺ , Foa ^R
YRp14- <i>leu2Δ1</i>	77147	<i>leu2Δ1</i>		Ura ⁺ , Foa ^R
YRp14- <i>trp1Δ63</i>	77148	<i>trp1Δ63</i>		Ura ⁺ , Foa ^R
pΔADE2	99604	<i>ade2::hisG::URA3::hisG</i>		One-step Foa ^R

^aThe set of four designer deletion plasmids in this table is available from ATCC as a kit (87472) of four strains.

^bCutting with the indicated enzyme will target the plasmid to the desired locus. In the case of pJL164, two enzymes are used to release the fragment containing the deleted genomic region of *URA3*. Deletion of *URA3* requires two homologous recombination events.

^cTwo-step gene replacements (indicated as Ura⁺, Foa^R) are required for most of these plasmids. For pJL164, which is a single-step replacement, cells are outgrown on YPD at 30°C prior to replica-plating to Foa medium. See Materials and Methods for details.

construction, all 5' overhangs created by restriction digests were blunted by filling in with the Klenow large fragment of *Escherichia coli* DNA polymerase, and all 3' overhangs were made blunt using the 3' to 5' exonuclease activity of T4 DNA polymerase. All sites indicated on the restriction maps were verified by digestion.

Construction of the MET15 plasmids, pRS401, pRS411 and pRS421 The pRS40X series precursor plasmid pJK142 (Keeney and Boeke, 1994) was digested with *NdeI*, blunted and the minimal complementing 1621 bp *EheI*-*ScaI* fragment of the *MET15* genomic locus was inserted to create pRS401 (*EheI* recognizes the same site as *NarI* but leaves a blunt end). pRS401 was digested with *AatII*, blunted, and a 514 bp *HincII*-*PstI* (blunt) fragment of pRSS84 containing the *CEN6/ARSH4* cassette (Sikorski and Hieter, 1989) inserted to create pRS411. pRS401 was digested with *AatII*, blunted, and the 1345 bp *HpaI*-*NdeI* (blunt) fragment of YEp24 containing the 2 μ *ori* (A form; Christianson *et al.*, 1992) was inserted to create pRS421.

Construction of the ADE2 plasmids, pRS402, pRS412 and pRS422 pJK142 was digested with *NdeI*, blunted, and a 2252 bp *BglII* (blunted) fragment of pASZ11 (kindly provided by Patrick Linder) containing a minimal complementing region of the *ADE2* genomic locus (Stotz and Linder, 1990) was inserted to create pRS402. The *CEN6/ARSH4* plasmid pRS412 and the 2 μ plasmid pRS422 were created by ligation of the 1246 bp *ApaLI* fragment of pRS402 and the 3781 bp *ApaLI* fragment of pRS402 with either the 1011 bp *CEN6/ARSH4* *ApaLI* fragment of pRS411 or the 1837 bp 2 μ *ApaLI* fragment of pRS421. It should be noted that these *ADE2* clones bear a silent A to G mutation at nucleotide 1243 of the GenBank sequence designed to destroy a *BglII* restriction site (Stotz and Linder, 1990).

Construction of the kanMX4 pRS400 plasmid pJK142 was digested with *NdeI*, blunted, and a 1483 bp *SmaI* to *EcoRV* fragment of pFA6A (Wach *et al.*, 1994) containing *kanMX4* was inserted, and kanamycin-resistant transformants were isolated. The initial clone was found to contain two copies of the vector sequence ligated in tandem with a single copy of *kanMX4*. This

clone was digested with *AatII* and re-ligated to create pRS400 which contains a single copy of the vector and *kanMX4*.

Construction of markerless pRS vectors The *CEN6/ARSH4* plasmid pGC25 and the 2 μ plasmid pGC26 were created by ligation of the 1246 bp *ApaLI* fragment of pRS402 and the 1527 bp *ApaLI* fragment of pJK142 with either the 1011 bp *CEN6/ARSH4* *ApaLI* fragment of pRS411 or the 1837 bp 2 μ *ApaLI* fragment of pRS421. These plasmids contain either the *CEN6/ARSH4* or the 2 μ sequence, but lack a selectable marker for use in *S. cerevisiae*. pGC25 (*CEN*) and pGC26 (2 μ) should be useful as the basis for a further extension of the pRS line to encompass an even greater diversity of markers.

Introduction of gene disruption mutations into yeast and strain history

We introduced the *ade2 Δ ::hisG* mutation into YPH681 (a direct descendant of FY2) to create YCB436 using the previously described *ADE2* disrupter p Δ ADE2 (Aparicio *et al.*, 1991), which results in deletion of the *ADE2* ORF (with the exception of six C-terminal amino acids) and replacement with a copy of the bacterial *hisG* gene. To create the correct starting strains for the designer deletions, YCB436 was crossed to BY378 and the resulting diploid was sporulated. Two spores from this cross, YCB451 and YCB452 were then gene converted to *URA3*⁺ by transformation with the 13 kb *EcoRI* fragment containing *URA3*⁺ (derived from pSK179 provided by S. Kunes) and selection for *Ura*⁺, thus creating strains BY397 and BY398, respectively. To introduce the *ura3 Δ 0* deletion, the *SpeI*-*XhoI* fragment from pJL164 was transformed into these two strains, transformants were grown for 1 day at 30°C on YPD plates to allow loss of pre-existing *Ura3* protein and development of the FOA^R phenotype (Ronne and Rothstein, 1988) and then replica-plated to 5-FOA plates. 5-FOA^R colonies were identified and patched onto YPD. These were screened for *URA3* deletions by a reversion analysis. The YPD plates were replica-plated to SC - *ura* plates and irradiated with UV-light at 100 J/m² using a Stratalinker (Stratagene; setting of 100 μ J \times 100/cm²). Following irradiation, plates were wrapped in foil to prevent photoreactivation and incubated for several days at 30°C. Using this test, *ura3 Δ 0* deletions were identified by their inability to revert to

Ura⁺, whereas point mutations reverted. Finally, correct *ura3Δ0* deletions in strains BY399 and BY401 were confirmed by Southern blot analysis (Ausubel *et al.*, 1987).

Figure 2 describes the method used to introduce the remaining designer deletion mutations. First, deleter plasmids pAD1, pAD2 and pAD4 were linearized at unique sites within each right flanking fragment (pAD1 with *Sal*I, pAD2 and pAD4 with *Cla*I) and transformed into the *ura3Δ0* strains. Genomic integrants were selected on SC-ura plates. Ura⁺ colonies were replica-plated to YPD plates to allow recombinational loss of the integrated *URA3* marker and pRS406 backbone and then replica-plated to 5-FOA plates to identify those that had become Ura⁻. 5-FOA-resistant colonies were picked and checked for loss of the targeted auxotrophic marker by replica-plating to SC-leu, SC-lys or lead-containing plates (*met15* strains are brown on these plates). Finally, deletions were confirmed by Southern analysis. The pAD1 transformation was performed in strain BY399 to create BY404, the pAD2 transformation was performed in strain BY401 to create BY406 and the pAD4 transformation was performed in strain BY406 to create BY411.

To create a set of strains consisting of a varying array of deletion alleles, BY411 (*MATa ura3Δ met15Δ0 trp1Δ63 his3Δ200 ade2Δ lys2Δ0*) was crossed to BY379 (*MATa his3Δ200*) and a spore was selected with the following genotype: *MATa met15Δ0 his3Δ200 lys2Δ0*. This strain, BY413, was mated to BY404 (*MATa ura3Δ leu2Δ0 trp1Δ63 his3Δ200 ade2Δ*). Tetrad dissection of four resulting diploids yielded an unexpected result: two spores of each tetrad grew slowly on rich medium, irrespective of genotype. Suspecting that these might have resulted from a single nuclear petite mutation, we tested all tetrads for growth on glycerol- and ethanol-containing rich medium (petite strains cannot utilize these carbon sources and so fail to grow). We found that these slow-growing spores did not exhibit a petite phenotype since all spores grew on these plates. We backcrossed one of the faster-growing spores from this cross (BY418; *MATa ura3Δ met15Δ0 trp1Δ63 his3Δ200 ade2Δ lys2Δ0 leu2Δ0*) to the parent FY4 (*MATa*) prototrophic strain. All spores obtained from tetrad dissection of this cross grew equally well, indicating that the mutation causing slow growth observed in the previous cross had been eliminated. The strain history is presented schematically in Figure 1).

Northern analysis of flanking genes

RNA was prepared from 10 ml of a log-phase culture (OD₆₀₀=1–2) grown in YPD at 30°C. The cells were washed once in water and resuspended in 0.3 ml RNA buffer (0.1 M-NaCl, 0.1 M-Tris base, 0.03 M-EDTA, 1% w/v *N*-lauryl sarcosine, pH 8.9–9.0) and frozen at –70°C. Upon thawing, 0.4 g glass beads, 0.15 ml phenol and 0.15 ml chloroform were added, and the cells were broken by vortexing for 10 min. Following a short spin to separate the phases, 1/10th volume 3 M-NaOAc and 2.5 volumes ice-cold EtOH were added to the aqueous layer to precipitate the nucleic acids (mostly RNA). The precipitate was dissolved in 100 μl of loading buffer (50% formamide, 25% water, 15% formaldehyde, 10% 10 × MOPS—0.2 M-morpholinopropane-sulfonic acid, 0.05 M-NaOAc, 0.01 M-Na₂EDTA; pH adjusted to 7.0 with NaOH). 10 μg RNA was first heated to 55°C for 15 min and then electrophoresed on a 1.2% agarose/formaldehyde gel as described (Ausubel *et al.*, 1987). The separated RNA was transferred to Genescreen Plus (ICN) and hybridized to the appropriate probe (Ausubel *et al.*, 1987) and Genescreen Plus protocol.

PCR protocol for PCR-mediated gene disruptions

Using primers consisting of 40 nts of gene-specific sequence at the 5' end followed by: 5'-CTGTGCGGTATTTACACCG-3' (left primer) and 5'-AGATTGTAAGAGAGTGCAC-3' (right primer), any auxotrophic marker can be amplified from a pRS40X integrating plasmid using the following PCR protocol: 94°C 2 min, [94°C 1 min, 55°C 1 min, 72°C 2 min] × 10 cycles, [94°C 1 min, 65°C 1 min, 72°C 2 min] × 20 cycles, 72°C 10 min. This protocol usually results in amplification of only the specific product. If yields are high enough, it is possible to directly transform yeast, but generally, 10-fold concentration by EtOH precipitation before transformation is desirable.

RESULTS AND DISCUSSION

A compilation of commonly found alleles of auxotrophic marker genes

To develop a strategy for construction of designer deletion strains, we first had to compile relevant information for existing auxotrophic selectable marker alleles. Many commonly used strains contain mutations in the auxotrophic

Table 4. A compilation of commonly used auxotrophic marker mutations.

Allele	Δ ORF?	Reverts?	Notes	Molecular description ^a	References
<i>ade2-101</i>	No	Yes	Ochre mutation, red colonies		
<i>ade2-BglII</i>	No	No	Red colonies	Frameshift (<i>BglII</i> site filled in at pos. 592)	Engelbrecht and Roeder (1990)
<i>his3Δ200</i>	Yes	No	Cold sensitive; high frequency of petite formation, especially during transformation	Δ 1 kb (– 205–835)	Struhl (1985); Fasullo and Davis (1988); Siram <i>et al.</i> YGM RNA processing mtg (1993)
<i>his3Δ1</i>	Partial	No		Δ 187 bp <i>HindIII–HindIII</i> internal (305–492)	Scherer and Davis (1979)
<i>his3-11,15</i>	No	No	Double mutant		Lau and G. R. Fink, unpublished
<i>leu2Δ1</i>	Partial	No		Δ 0.6 kb, <i>EcoRI–ClaI</i> internal (163–649)	Sikorski and Hieter (1989)
<i>leu2-3,112</i>	No	No	Double mutant	<i>leu2-3</i> is a +1 frameshift mutation	Hinnen <i>et al.</i> (1978); Gaber and Culbertson (1982)
<i>lys2-801</i>	No	Yes	Amber mutation		
<i>lys2Δ202</i>	Partial	No		Δ 1.0 kb, <i>XhoI–HpaI</i> internal (1813–2864)	Winston <i>et al.</i> (1995)
<i>trp1Δ1</i>	Yes	No	Cold sensitive ^b , weak galactose inducer (deletes <i>GAL3</i> UAS), removes <i>ARS1</i> , also called <i>trp1-901</i>	Δ 1.45 kb, <i>EcoRI–EcoRI</i> (– 102 to 1352)	Sikorski and Hieter (1989)
<i>trp1Δ63</i>	Partial	No	Cold sensitive ^b	Δ 0.6 kb, <i>EcoRI–HindIII</i> (– 102 to 513)	Sikorski and Hieter (1989)
<i>trp1-289</i>	No	Yes	Cold sensitive ^b		
<i>ura3-52</i>	No	No		Ty1 insertion (transcribing left to right) at pos. 121	Rose and Winston (1984)
<i>ura3-1</i>	No	Yes			
<i>Alleles described in this study</i>					
<i>ade2Δ::hisG</i>	No	No			Aparicio <i>et al.</i> (1991)
<i>leu2Δ0</i>	Yes	No	Designer deletion		This study
<i>lys2Δ0</i>	Yes	No	Designer deletion		This study
<i>met15Δ0</i>	Yes	No	Designer deletion		This study
<i>ura3Δ0</i>	Yes	No	Designer deletion		This study

An updatable version of this table is maintained by SGD (<http://genome-www.stanford.edu/Saccharomyces/>).

^aThe sequence coordinates are relative to the first ATG of the selectable marker ORF, in which the A residue is defined as +1.

^bAll *Trp*[–] strains are cold sensitive (Singh and Manney, 1974).

marker genes—namely, point mutations or small internal deletions which are not conducive to successful PCR-mediated gene disruption. These auxotrophic loci retain extensive homology with the prototrophic marker gene segment of the PCR

product, leading to high levels of mistargeting. We have compiled a table of many of these commonly used alleles (Table 4) which should be useful in determining a strain's adaptability for PCR-mediated gene disruption.

PCR-mediated gene disruption is variably successful in its degree of targeting the locus of interest, even when complete deletion alleles corresponding to the marker gene being introduced are used. The reason for this variability in efficiency is not entirely clear but appears to be related primarily to the targeting sequences that flank the target gene (Q. Feng and J.D.B., unpublished data), and to a lesser extent to the nature of the disrupting auxotrophic marker. It is important to note that the commonly used segment of *LEU2* (the *XhoI*–*SalI* fragment found in the pRS vectors) contains 240 bp of δ (Ty2 LTR) sequence at its 5' end. This may lead to a higher frequency of mistargeting than with the other auxotrophic markers.

Complete deletion alleles of URA3, LEU2, LYS2 and MET15

Commonly used strains of the S288C lineage contain only four auxotrophic alleles that are well-defined deletions, namely *his3 Δ 200*, *leu2 Δ 1*, *trp1 Δ 1*, and *trp1 Δ 63*. Both the *his3 Δ 200* and *trp1 Δ 1* mutations completely remove the protein coding regions, whereas *trp1 Δ 63* leaves intact the 3' end of the gene and *leu2 Δ 1* is an internal deletion (Table 4). All of these mutations except *leu2 Δ 1* work well for the method of PCR-mediated gene disruption, resulting in proper gene disruptions 30–100% of the time. Thus, new designer deletion alleles of *TRP1* and *HIS3* have not been constructed. However, PCR-mediated gene disruptions using other commonly used auxotrophic alleles have been difficult to obtain because of the high background of gene conversion. For this reason we set out to construct an isogenic set of strains in which *URA3*, *LYS2*, *LEU2* and *MET15* were completely deleted.

The strategy for the designer deletion alleles (designated $\Delta 0$) is depicted in Figure 2. Approximately 1 kb 'left' and 'right' flanking regions of the auxotrophic marker to be deleted were cloned into a *URA3* integrating vector. Linearization of the resulting deleter plasmid within the right flanking sequence and transformation of a *ura3 Δ 0* strain results in integration of the plasmid at the auxotrophic marker locus. Subsequent recombination between the duplicated left or right flanks results in 5-FOA resistance (due to excision of the *URA3* plasmid) and leads to acquisition of the appropriate auxotrophy (in principle, 50% of the time).

Because this strategy involves integration of a *URA3* containing plasmid, it was important that our starting strain was not only *Ura*[−], but also lacked sequences overlapping with the plasmid *URA3* gene. To completely delete *URA3*, the plasmid pJL164, containing a genomic 4.0 kb *BglII*–*BamHI* fragment in which the region from *HindIII* to *SmaI* encompassing the *URA3* gene has been deleted (Figure 3), was digested with *SpeI* and *XhoI* to liberate a DNA fragment spanning the deletion (Table 3). This was transformed into the *URA3*⁺ strains BY397 and BY398 and *Ura*[−] colonies were selected on 5-FOA. Reversion tests and Southern blotting confirmed the acquisition of the *ura3 Δ 0* allele in strains BY399 and BY401.

All four designer deletion plasmids completely remove the open reading frame encoding the appropriate auxotrophic marker. They also remove several hundred bp of 5' flanking region, and as much 3' flanking region as is practical. Ideally, there should be no homology between the marker segment in the plasmid to be used and the deletion in the chromosome. In two cases (*ura3* and *met15*) it was possible to remove all homology between plasmid marker segment and chromosomal deletion. The details of the design of each deletion were dictated by what was known about the nature of flanking genes; often, as at the 3' end of *LYS2*, there was not much room to maneuver due to the proximity of the adjacent gene (Figure 3). Both *MET15* and *LEU2* are flanked by tRNA genes and δ elements and in the case of *LEU2*, an entire Ty2 element. Because the segment of *LEU2* commonly used in cloning vectors contains part of this Ty2 element as well as a tRNA^{Leu} gene, it was necessary to delete the Ty2 element, the tRNA gene, and *LEU2* in order to eliminate overlap with the vector segment, at least at one end of the marker gene. Thus the *leu2 Δ 0* allele is considerably larger than the rest. No unusual phenotypes have resulted from this deletion.

To create the *leu2 Δ 0* and *lys2 Δ 0* strains, pAD1 was linearized with *SalI* and pAD2 with *Clal* (Table 3 and Figure 2) and transformed into BY399 and BY401 respectively. *Ura*⁺ colonies were patched onto SC–*ura*, replica-plated to YPD (to allow loss of the *URA3*⁺ and flanking vector sequences) and replica-plated to 5-FOA plates. Papillae from the 5-FOA plates were streaked onto YPD and replica-plated to either SC–*leu* or SC–*lys* to identify auxotrophs (Figure 2). Of 24 5-FOA^R papillae from the pAD1

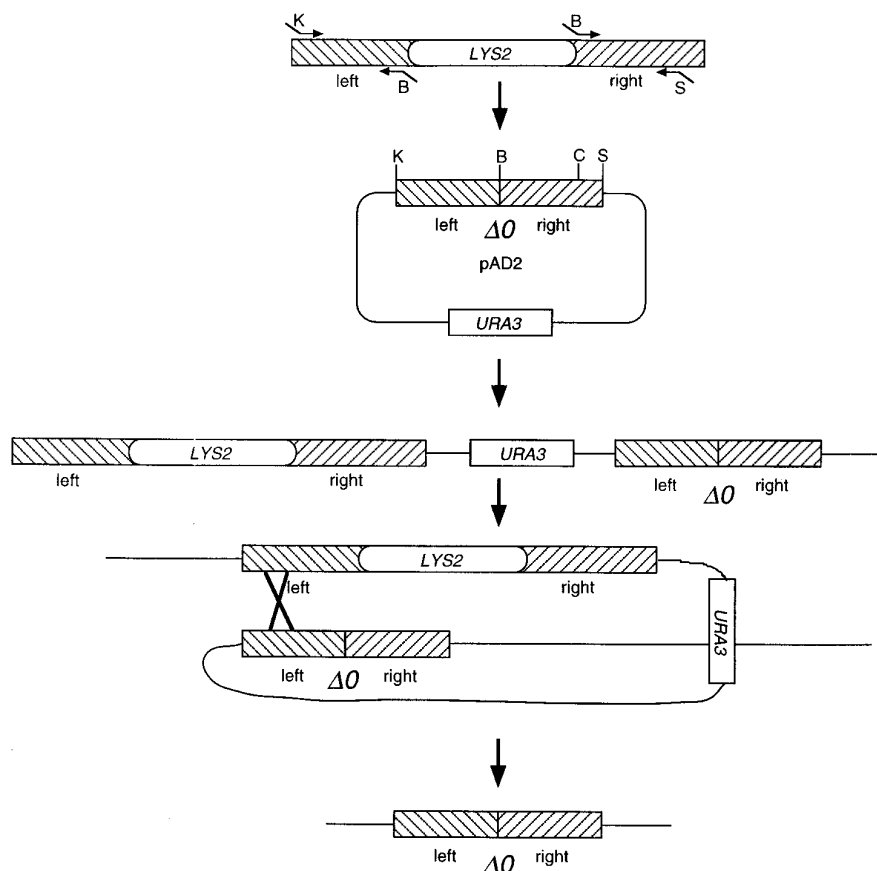

Figure 2. Method of construction of designer deletion strains. An example is given in which *LYS2*⁺ is deleted to create *lys2* $\Delta 0$. The *LYS2* ORF is indicated by a white oval and the hatched regions indicate left and right flanking sequences. Lines with arrows indicate oligonucleotide primers for PCR-amplification of the flanking regions, and the restriction sites engineered into these oligos are indicated by K, *KpnI*; B, *BamHI* or S, *SacI*. Using these oligos, the flanking regions are PCR-amplified, cut with the indicated enzymes and cloned into pRS406 to create a deleter plasmid; in this case, pAD2. pAD2 is then linearized at the unique *ClaI* (C) site in the right flanking region and transformed into yeast. Integration of the linearized vector within the genomic *LYS2* right region results in the configuration of sequences shown in the middle panel of the diagram. Recombination between the two left regions results in deletion of the *LYS2*⁺ and vector sequences. Not shown, but equally likely, is recombination between the two right regions which results in restoration of the wild-type *LYS2*⁺ allele.

transformation, three were Leu⁻, and of 24 5-FOA^R papillae from the pAD2 transformation, six were Lys⁻. The deletions were confirmed by genomic Southern analysis (Figure 4).

The *met15* $\Delta 0$ mutation was introduced into BY406 (the *lys2* $\Delta 0$ derivative) in a similar fashion. Plasmid pAD4 was linearized with *ClaI* and transformed. Following 5-FOA selection, candidate strains were streaked onto YPD plates and replica-plated to lead-containing plates. When grown on these plates *met15* strains are brown in

color, identifying those strains in which recombinational loss of the *URA3*⁺ and vector sequences had resulted in a Met⁻ phenotype. The *met15* $\Delta 0$ allele was confirmed by Southern analysis (Figure 4).

Using the *ADE2* disrupter plasmid p Δ ADE2 (Aparicio *et al.*, 1991, the *ade2* Δ ::*hisG*::*URA3*::*hisG* (originally referred to as *ade2* Δ by Aparicio *et al.*) mutation was introduced into these strains; these were converted to *ade2* Δ ::*hisG* alleles by plating on 5-FOA as above. Since six C-terminal

amino acids remain of the *ADE2* ORF, the *ade2Δ::hisG* mutation is not technically a designer deletion, and it has been shown to be useful in PCR-mediated gene disruption (D. Gottschling, pers. comm.).

Because these strains are intended to be used for, among other things, the systematic genetic analysis of genes of unknown function, it was important to establish that expression of the ORFs neighboring the deleted auxotrophic markers was unaffected in these deletion strains. This seemed especially important because many yeast workers have found that two of the commonly used deletion alleles, *his3Δ200* and *trp1Δ1*, have 'collateral' phenotypes that are sometimes undesirable due to effects on adjacent genes. *his3Δ200* strains display an increased rate of petite formation, presumably due to effects on expression of the neighboring *PET56* gene. *trp1Δ1* removes *ARS1* (with no obvious phenotype) and partially disables the neighboring *GAL3* gene by removing a portion of its UAS. Finally, both *trp1Δ63* and *trp1Δ1* strains share a cold-sensitivity phenotype which all Trp^- strains exhibit (Singh and Manney, 1974).

It is impossible to totally rule out effects on flanking genes but the deletions were designed to minimize the possibility of such effects. In the construction of the *leu2* and *met15* deletions, tRNA genes that are part of multigene families were removed in addition to the auxotrophic marker. The phenotypic consequence of this is likely to be minimal, based on experiences with other multi-gene tRNA families (Byström and Fink, 1989; Åström and Byström, 1993). All of the designer deletions remove marker genes that are flanked by convergently transcribed neighboring genes (Figure 3); effects on the flanking genes are thus expected to be minimal. Nevertheless, the possibility of altered transcript sizes and transcriptional level of neighboring genes was investigated by Northern analysis. RNA was prepared from BY418 (which has all four designer deletion mutations) and FY2 (the wild-type strain), and left and right flanking probes (Figure 3) were used to detect the transcription of neighboring ORFs; in no case was the expression of a neighboring ORF significantly affected (Figure 5; compare the neighboring gene specific transcript with the *Ty1* loading control transcript). However, our analyses did detect one minor but interesting expression pattern change. The *LEU2* neighboring ORF, *YCL17C* (reading toward *LEU2*), appears to direct a major transcript and numerous larger minor transcripts.

In the *leu2Δ0* strain, the overall levels of the transcripts are slightly reduced and in particular, the largest transcripts appear to be missing. Such an observation is consistent with the possibility that the larger transcripts normally terminate within the deleted region.

A set of designer deletion strains

To obtain strains with numerous different combinations of auxotrophic alleles, 206 tetrads were dissected from a cross between FY3 and BY418 (Figure 1). This cross gave ~30% sporulation and 96.5% spore viability using the conditions described in Materials and Methods. A subset of the strains from this cross identified in Table 1, which should prove generally useful to the yeast community, has been deposited with the ATCC.

New pRS plasmids with ADE2, MET15 and kanMX4 markers

The pRS vector series is a set of *S. cerevisiae* shuttle plasmids that are in wide use. Much of their appeal derives from their small size, modular design, minimal length marker segments, useful polylinker and consistency of structure. Also, complete DNA sequence files exist for these plasmids, greatly facilitating construction and analysis of recombinant plasmids. The original set of pRS vectors (the pRS300 series) were based on pBluescript KS+ (Sikorski and Hieter, 1989) and included both integrating and centromere-containing versions; the pRS400 series is based on pBSII SK+ (Stratagene; Christianson *et al.*, 1992) and also includes 2 μ versions. This latter series is more generally useful for several reasons: (1) the *lacZ* α -complementation is improved over the pRS300 series; (2) the polylinker is flanked by *Bss*HII sites, allowing a simple assessment of insert size to be carried out and facilitating swapping of inserts from one vector to another; and (3) the pRS400 series is more complete, including integrating, *CEN*, and high copy versions. The 'code' for the pRS vectors is simple: the second digit (0, 1 or 2) specifies the plasmid type (integrating, *CEN* or 2 μ , respectively) and the third digit specifies the selectable marker (see Table 5).

We constructed new integrating, *CEN* and 2 μ plasmids for use with the *ade2Δ* and *met15Δ0* strains (Figure 6). In all cases, the plasmid backbone is identical to the pRS400 series of plasmids, and the selectable markers were inserted into the same restriction site as had been utilized for



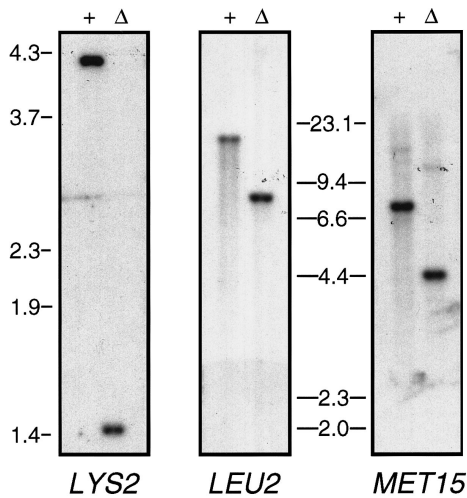

Figure 4. Genomic DNA blot analysis of deletion alleles. DNA was isolated from the wild-type strain FY5 (+) and the multiple deletion strain BY418 (Δ). Approximately 1 μ g of genomic DNA was digested with *Bst*XI (*LYS2*), *Pst*I (*LEU2*) or *Kpn*I (*MET15*), and fractionated on a 1% agarose gel. Following transfer to a nylon filter, each blot was probed with a gene-specific flanking probe (as depicted in Figure 3): *LYS2*, left flank; *LEU2*, right flank; and *MET15*, right flank. Expected product sizes are: *LYS2*, wild-type genomic *Bst*XI fragment is 4 kb and the deletion *Bst*XI fragment is 1.4 kb; *LEU2*, wild-type genomic *Pst*I fragment is 12 kb and the deletion *Pst*I fragment is 7.6 kb; *MET15*, wild-type genomic *Kpn*I fragment is 6.8 kb and the deletion *Kpn*I fragment is 4.4 kb. The observed *LEU2* fragment sizes do not agree with the expected; this is probably because chromosome III sequence was not obtained from this strain background (Oliver *et al.*, 1992). However, the difference in size between the deleted and wild-type *LEU2* fragments agrees with the sequence. DNA marker sizes are in kb as indicated.

the pRS plasmids (Sikorski and Hieter, 1989; Christianson *et al.*, 1992). In the case of the *ADE2* plasmids, pRS402, pRS412 and pRS422, the fragment inserted represents a minimal complementing fragment as previously determined by

Stotz and Linder (1990). For the *MET15* plasmids, pRS401, pRS411 and pRS421, a minimal length complementing fragment as defined by a complementation analysis (Figure 7). The *Nar*I–*Sca*I fragment was the smallest strongly-complementing fragment and was cloned into the pRS plasmid backbones. The *ADE2* and the *MET15* plasmids were demonstrated to fully complement the *ade2* Δ and *met15* Δ mutations as judged by colony growth on appropriate selective media. In the course of these experiments we noted that unlike all of the other auxotrophic designer deletion markers, the *met15* Δ strain eventually (and at a low frequency) spawns slow-growing pseudo-*Met*⁺ papillae when replica-plated as a thick patch on YPD medium to SD plates. Such growth is maximal at 22°C, drops dramatically at 25°C and decreases linearly from 30–37°C, where little growth is observed. These pseudo-*Met*⁺ papillae are not true revertants because they form black colonies on lead plates, like the parental *met15* mutant strain. Most importantly, these colonies do not grow when restreaked on methionine-free medium, so they are not true *Met*⁺ cells. Our working hypothesis is that these colonies represent mutants that are more efficient at scavenging methionine or cysteine from adjacent cells. This phenomenon will be described in more detail elsewhere, but does not create much of a practical problem. Using standard LiOAc transformation procedures, these pseudo-*Met*⁺ colonies did not cause any detectable background (i.e. no visible colonies on a control plate to which no pRS4X1 plasmid DNA had been added). In fact no colonies appeared on the no DNA plate even after 10 days of growth. Finally, we constructed the integrating plasmid pRS400, which contains the *kanMX4* gene (Wach *et al.*, 1994). This is useful for use as a template for PCR-mediated gene disruption. Available information on the

Figure 3. Genomic structure of deletion alleles and overlap with vector segments. The genomic region encompassing each of the five deletions is presented as a six-phase ORF analysis. To the left of each are indicated the three possible reading frames of the plus and minus strands. Lines from the top to the bottom of each frame indicate stop codons in that frame, and lines from the middle to the bottom of each frame indicate methionine residues in that frame (output is from the DNA Strider 1.2 ORF Map function). Each ORF is identified by its gene name or ORF designation, and above each diagram, tRNA and Ty elements have been identified. All nucleotide numbers are defined by +1 being assigned to the A of the first ATG in the auxotrophic marker ORF to prevent possible confusion resulting from renumbering of sequences in databases. The bold line under each diagram indicates the extent of each deletion. Below this is a thin line indicating the extent of the fragment of genomic sequence encoding the auxotrophic marker cloned into the corresponding pRS vector. Finally, the left and right flanking regions which were used as probes for the Southern and Northern analyses in this paper are indicated. In the cases of *LEU2*, *LYS2* and *MET15*, these are identical to the left and right flanking regions that were PCR-amplified for the deleter constructs (Figure 2). Note that the scale is the same for all regions except for the *LEU2* region, which had to be compressed to accommodate the very large deletion which removed an adjacent Ty2 element as well as *LEU2* itself.

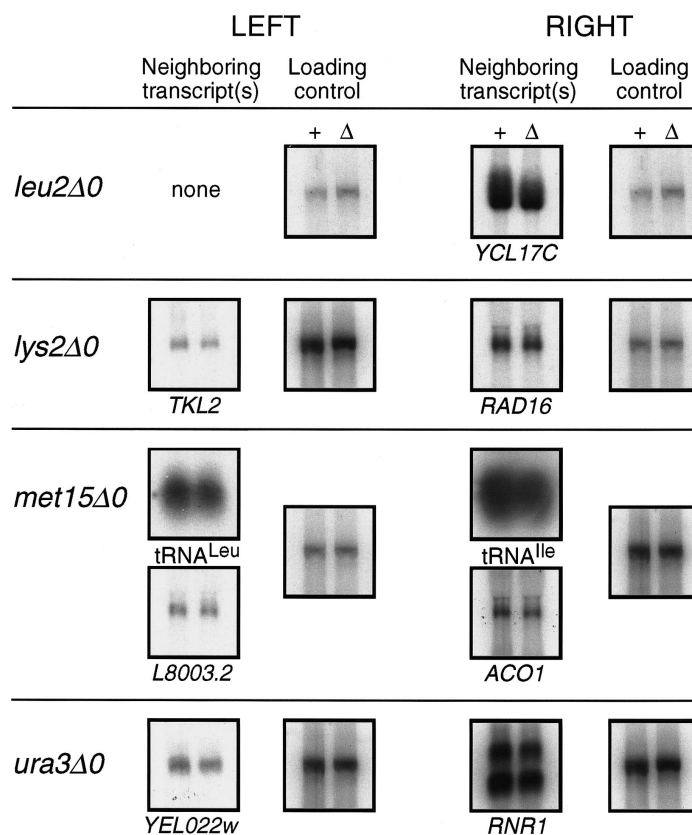

Figure 5. RNA blot analysis for effects on expression of neighboring genes. RNA was isolated from the wild-type strain FY5 (+) and the multiple deletion strain BY418 (Δ). Multiple samples containing 9.8 μ g total RNA from each strain were fractionated on a 1.2% formaldehyde agarose gel. Following transfer to a nylon filter, the blot was cut into strips and each was probed with a gene-specific left flank probe (probes are indicated in Figure 3). Following this, the blots were reprobed with gene-specific right probes. For all panels, the wild-type sample is presented on the left as indicated for *LEU2*. In all cases, transcript sizes were consistent with the sizes of encoded ORFs or known transcripts; the inferred identities of the transcripts are indicated below each panel. To allow comparison between samples, the Ty transcript is included as a loading control. Fortunately, two left probes (*LEU2* and *MET15*) contained Ty LTR sequences. The *LEU2* left probe was used to reprobe those blots in which the Ty1 transcript had not yet been visualized. It should be noted that based on the sequence no transcript was expected (i.e. there were no known ORFs or genes) to the left of *leu2Δ0* and no hybridizing bands were seen with this probe.

sequences and availability of the complete series of pRS400 series vectors is summarized in Table 5.

Universal primers for PCR-mediated gene disruption using pRS plasmid templates

A pair of primer segments was designed which can be universally used to amplify any selectable

marker from the pRS set of plasmids (Figure 8). Addition of 40 nts of sequence specific to the gene of interest at the 5' ends of the primers results in a single set of 60 nt primers which can be used to delete the gene of interest with either *URA3*, *TRP1*, *HIS3*, *LEU2*, *LYS2*, *ADE2*, *MET15* or *kanMX4*. We have used this strategy to disrupt a number of genes in our laboratories.

Table 5. The pRS400 series of vectors.

Plasmid and type ^a	Selectable marker	Accession numbers ^b	Available from ^c	References
pRS400 (I)	<i>kanMX4</i>	U93713	Pending	Wach <i>et al.</i> (1994), this work
pRS401 (I)	<i>MET15</i>	U93714	ATCC 87473	This work
pRS411 (C)	<i>MET15</i>	U93715	ATCC 87474	This work
pRS421 (2)	<i>MET15</i>	U93716	ATCC 87475	This work
pRS402 (I)	<i>ADE2</i>	U93717	ATCC 87477	This work
pRS412 (C)	<i>ADE2</i>	U93718	ATCC 87478	This work
pRS422 (2)	<i>ADE2</i>	U93719	ATCC 87479	This work
pRS403 (I)	<i>HIS3</i>	U03443	ST 217403	
pRS413 (C)	<i>HIS3</i>	U03447	ST 217413	
pRS423 (2)	<i>HIS3</i>	U03454	ATCC 77104	Christianson <i>et al.</i> (1992)
pRS404 (I)	<i>TRP1</i>	U03444	ST 217404	
pRS414 (C)	<i>TRP1</i>	U03448	ST 217414	
pRS424 (2)	<i>TRP1</i>	U03453	ATCC 77105	Christianson <i>et al.</i> (1992)
pRS405 (I)	<i>LEU2</i>	U03445	ST 217405	
pRS415 (C)	<i>LEU2</i>	U03449	ST 217415	
pRS425 (2)	<i>LEU2</i>	U03452	ATCC 77106	Christianson <i>et al.</i> (1992)
pRS406 (I)	<i>URA3</i>	U03446	ST 217406	
pRS416 (C)	<i>URA3</i>	U03450	ST 217416	
pRS426 (2)	<i>URA3</i>	U03451	ATCC 77107	Christianson <i>et al.</i> (1992)
(pRS317 ^d) (C)	<i>LYS2</i>		ATCC 77157	Sikorski and Boeke (1990)

^aPlasmid type is in parentheses: I, integrating plasmid; C, centromeric (*CEN/ARS*) plasmid; 2, 2 μ origin-containing plasmid.

^bDNA sequence accession number. DNA sequences are available from VecBase (URL: <http://biology.queensu.ca/~miseners/vector.html>) or GenBank.

^cATCC, American Type Culture Collection, Rockville, MD; ST, Stratagene, La Jolla, CA. Sets of pRS vectors are available in kit form from ATCC (pRS401, 411, 421, 87476; pRS402, 412, 422, 87480; pRS423, 424, 425, 426, 77108).

^dNo pRS400 series plasmids exist for *LYS2* at this time.

Other applications for the designer deletion strains and new plasmids

Although we have focused on the application of PCR-mediated gene disruption in this paper, we envision that the designer deletion alleles will be the alleles of choice for a very wide range of applications. They are ideal as transformation markers because they cannot revert (with the special exception of *met15* noted above). The ability to knock out genes of interest by the PCR approach is enhanced by expanding the set of available markers in pRS vectors. This is especially useful in the study of multigene families (Brachmann *et al.*, 1995) many of which have been revealed by the completion of the *S. cerevisiae* genome sequence. By synthesizing a single pair of primers for each target gene of interest, the investigator has the ability to knock out a member of the gene family with any of eight currently available markers in the pRS vectors (Table 5). If a heavily marked strain such as BY418 is used as the

recipient, up to eight different genes can be knocked out before running out of selectable markers. In addition, the alleles that have no overlap (or minimal overlap only at one end of the marker) will be ideal for studies of DNA recombination in which lack of homology between e.g. a plasmid and the chromosome is critical. It should be pointed out that an alternative and elegant strategy to solve the same problem was developed by Wach *et al.* (1994), who constructed the *kanMX4* marker, which has no homology with the yeast genome and confers dominant resistance to G418, and hence can be used with strains of any background. Although *kanMX4* does work as a selectable marker, G418 is an expensive reagent to use routinely, and expression of the drug resistance requires an outgrowth period prior to plating on G418 and so is somewhat less convenient. Both strategies further enrich the already extensive molecular genetic toolkit available for *S. cerevisiae*.

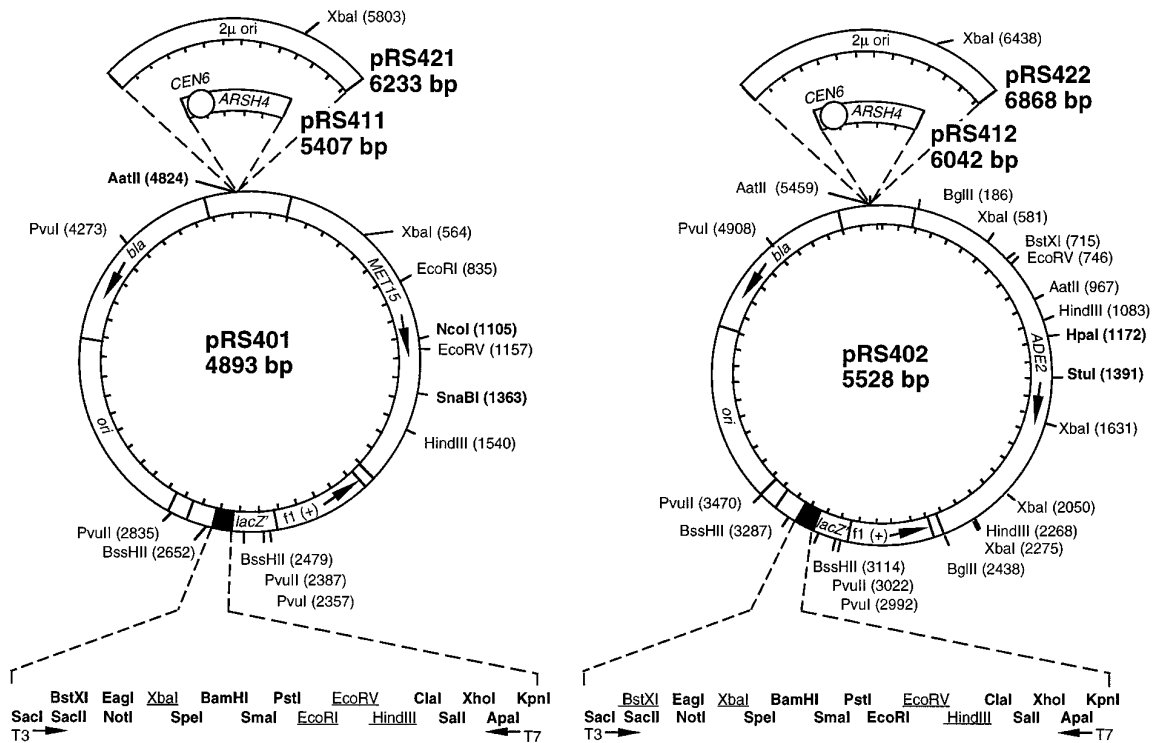

Figure 6. New pRS400 series *S. cerevisiae*-*E. coli* plasmid vectors. Restriction maps of the pRS vectors. Unique restriction sites are shown in bold letters. For emphasis, sites in the polylinker that are no longer unique have been underlined. Maps of the pRS40X set may be converted to either the pRS41X set by the insertion of the *CEN/ARS* cassette or to the pRS42X set by insertion of the 2 μ cassette (in either case, the *AatII* site is destroyed). The numbering system is the same for all three sets. The direction of T3 or T7 polymerase transcription is as labeled. Numbers of parentheses refer to base pairs. Maps are drawn to scale.

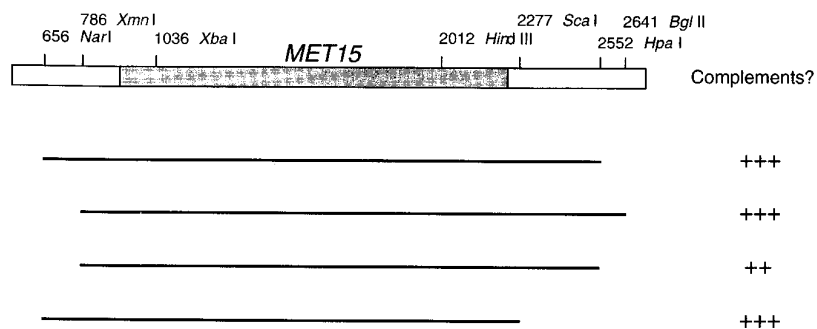

Figure 7. Definition of the minimum complementing region of *MET15*. A schematic diagram of the *MET15* genomic region indicating relevant restriction sites. Lines below the restriction site diagram indicate the extent of the fragment tested for complementation of a *met15* strain, and the column at the right indicates a qualitative analysis of the ability of each fragment to complement the *met15* allele for growth. In all cases, the fragments were cloned into the polylinker of pRS413 and yeast (strain 31-10C; Cost and Boeke, 1996) transformants were selected on SD+Ura medium, and complementation analyses were performed by comparing colony sizes on selective medium between a wild-type *MET15*⁺ strain and the transformed strain.

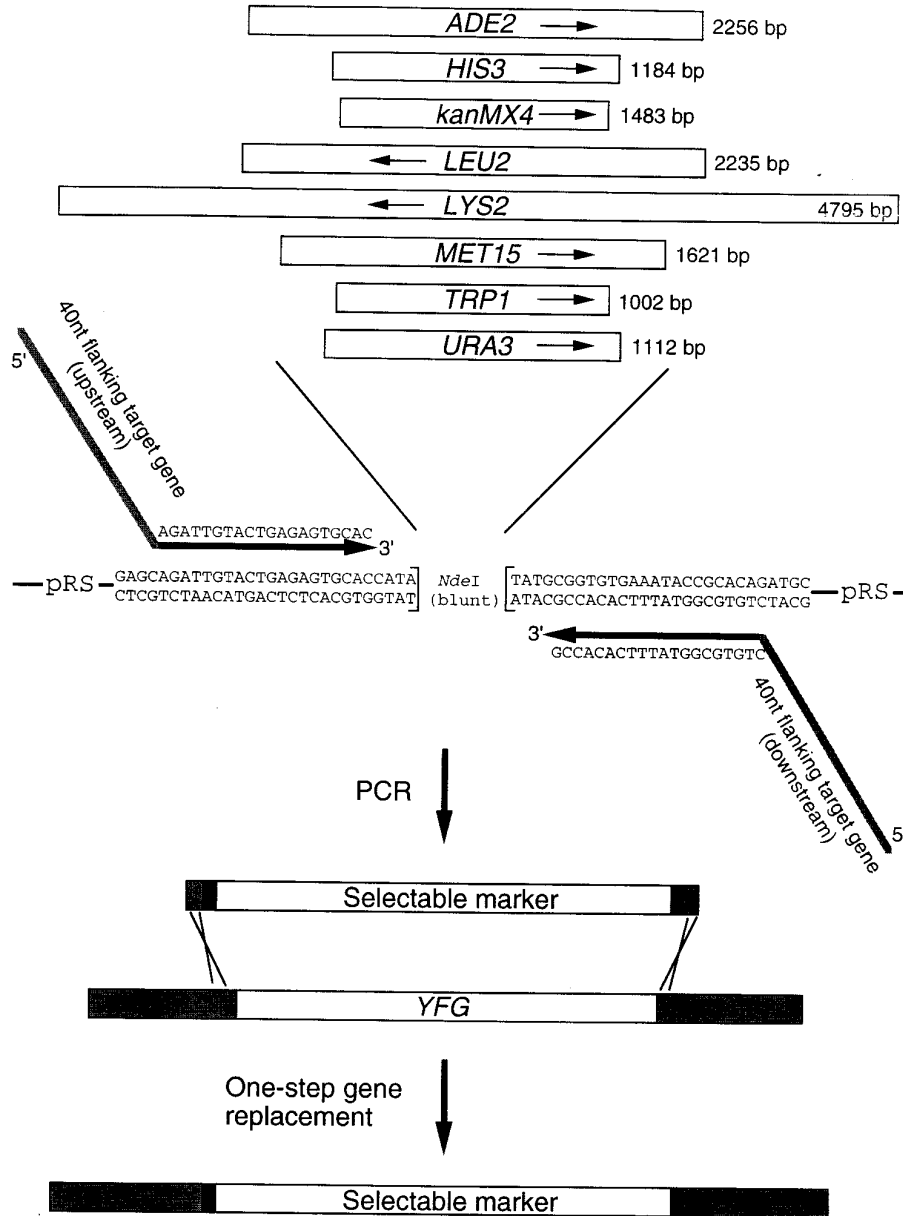

Figure 8. A universal primer set for producing PCR-mediated gene disruption cassettes. The double-stranded sequence shown represents about 50 bp surrounding a unique *NdeI* site in the parental plasmid backbone of all pRS400 series vectors [the parental backbone is a pBLUESCRIPT/pBLUESCRIBE hybrid made by ligating a *PvuI* fragment of pBLUESCRIPT II-SK (containing the polylinker region) to a *PvuI* fragment of pBLUESCRIBE (containing unique *NdeI* and *AatII* sites)]. Minimal DNA segments that encode each of the selectable markers (arrows indicate transcriptional orientation) shown above were blunt-end ligated into the blunted *NdeI* site for each pRS400 series vector. A single pair of oligos can therefore be used to amplify by PCR each of the selectable marker genes. Sequences of oligos used for amplification of the selectable marker genes are as indicated. Both oligos are drawn 5' to 3'. As indicated, 40 nts of sequence from either the upstream or downstream flanking region of the gene to be deleted, in this case *YFG*, is added to the 5' end of each oligo. PCR-amplification of the auxotrophic marker allele is performed using any pRS integrating vector as a template (this is possible because the oligos are specific to the sequence just upstream and downstream of the *NdeI* vector site into which all markers were introduced). The resulting double-stranded PCR product is then transformed into yeast, replacing the genomic *YFG* allele by a double cross-over event. The resulting disruptions contain any of eight selectable markers transcribed in the orientations indicated.

ACKNOWLEDGEMENTS

We thank our colleagues in the yeast community for providing information on alleles and for plasmids. We thank Hugh Rienhoff, Fred Winston, Marc Vidal and Mike Fasullo for helpful discussions and Kexin Yu for technical assistance. We thank the NIH for supporting research in our laboratories.

REFERENCES

- Aparicio, O. M., Billington, B. L. and Gottschling, D.E. (1991). Modifiers of position effect are shared between telomeric and silent mating-type loci in *S. cerevisiae*. *Cell* **66**, 1279–1287.
- Åström, S. and Byström, A. (1993). The yeast initiator tRNA^{Met} can act as an elongator tRNA^{Met} *in vivo*. *J. Mol. Biol.* **233**, 43–58.
- Ausubel, F., Brent, R., Kingston, R. E., *et al.* (1987). *Current Protocols in Molecular Biology*. John Wiley and Sons, New York.
- Baudin, A., Ozier-Kalogeropoulos, O., Deanouel, A., LaCrute, F. and Cullin, C. (1993). A simple and efficient method for direct gene deletion in *Saccharomyces cerevisiae*. *Nucl. Acids Res.* **21**, 3329–3330.
- Boeke, J. D., Lacroute, F. and Fink, G. R. (1984). A positive selection for mutants lacking orotidine 5'-phosphate decarboxylase activity in yeast: 5-fluoroorotic acid resistance. *Molec. Gen. Genet.* **197**, 345–346.
- Brachmann, C. B., Sherman, J. M., Devine, S. E., *et al.* (1995). The *SIR2* gene family, conserved from bacteria to humans, functions in silencing, cell cycle progression, and chromosome stability. *Genes Dev.* **9**, 2888–2902.
- Byström, A. S. and Fink, G. R. (1989). Molecular and functional analysis of the methionine initiator tRNA genes (*IMT*) in yeast. *Mol. Gen. Genet.* **216**, 276–286.
- Christianson, T. R., Sikorski, R., Dante, M., Schero, J. and Hieter, P. (1992). Multifunctional yeast high copy-number shuttle vectors. *Gene* **110**, 119–122.
- Cost, G. C. and Boeke, J. D. (1996). A useful colony colour phenotype associated with the yeast selectable/counters selectable marker *MET15*. *Yeast* **12**, 939–941.
- Engbrecht, J. and Roeder, G. S. (1990). *MER1*, a yeast gene required for chromosome pairing and genetic recombination, is induced in meiosis. *Mol. Cell. Biol.* **10**, 2379–2389.
- Fasullo, M. T. and Davis, R. W. (1988). Direction of chromosome rearrangements in *Saccharomyces cerevisiae* by use of *his3* recombinational substrates. *Mol. Cell. Biol.* **8**, 4370–4380.
- Gaber, R. and Culbertson, M. R. (1982). The yeast frameshift suppressor gene *SUF16-1* encodes an altered glycine tRNA containing the four-base anticodon 3'CCCG-5'. *Gene* **19**, 163–172.
- Hinnen, A., Hicks, J. B. and Fink, G. R. (1979). Transformation of yeast. *Proc. Natl. Acad. Sci. USA* **75**, 1929–1933.
- Keeney, J. B. and Boeke, J. D. (1994). Efficient targeted integration at *leu1-32* and *ura4-294* in *Schizosaccharomyces pombe*. *Genetics* **136**, 849–856.
- Lorenz, M. C., Muir, R. S., Lim, E., *et al.* (1995). Gene disruption with PCR products in *Saccharomyces cerevisiae*. *Gene* **158**, 113–117.
- Oliver, S. G., van der Aart, Q. J. M., Agostoni-Carbone, M. L., *et al.* (1992). The complete DNA sequence of yeast chromosome III. *Nature* **357**, 38–46.
- Ono, B., Ishii, N., Fujino, S. and Aoyama, I. (1991). Role of hydrosulfide ions in methylmercury resistance in *Saccharomyces cerevisiae*. *Appl. Env. Microbiol.* **57**, 3183–3186.
- Ronne, H. and Rothstein, R. (1988). Mitotic sectored colonies: evidence of heteroduplex DNA formation during direct repeat recombination. *Proc. Natl. Acad. Sci. USA* **85**, 2696–2700.
- Rose, M. and Winston, F. (1984). Identification of a Ty insertion within the coding sequence of the *S. cerevisiae* *URA3* gene. *Molec. Gen. Genet.* **193**, 557–560.
- Rose, M. D., Winston, F. and Hieter, P. (1990). *Methods in Yeast Genetics. A Laboratory Course Manual*. Cold Spring Harbor Laboratory Press, Cold Spring Harbor, New York.
- Rothstein, R. J. (1983). One-step gene disruption in yeast. *Meth. Enzymol.* **101**, 202–211.
- Scherer, S. and Davis, R. W. (1979). Replacement of chromosome segments with altered DNA sequences constructed *in vitro*. *Proc. Natl. Acad. Sci. USA* **76**, 4951–4955.
- Sikorski, R. S. and Boeke, J. D. (1990). *In vitro* mutagenesis and plasmid shuffling: from cloned gene to mutant yeast. *Meth. Enzymol.* **194**, 302–318.
- Sikorski, R. S. and Hieter, P. (1989). A system of shuttle vectors and yeast host strains designed for efficient manipulation of DNA in *Saccharomyces cerevisiae*. *Genetics* **122**, 19–27.
- Singh, A. and Manney, T. R. (1974). Genetic analysis of mutations affecting growth of *Saccharomyces cerevisiae* at low temperatures. *Genetics* **77**, 651–659.
- Stotz, A. and Linder, P. (1990). The *ADE2* gene from *Saccharomyces cerevisiae*: sequence and new vectors. *Gene* **95**, 91–98.
- Struhl, K. (1985). Naturally occurring poly(dA-dT) sequences are upstream promoter elements for constitutive transcription in yeast. *Proc. Natl. Acad. Sci. USA* **82**, 8419–8423.
- Wach, A., Brachat, A., Poehlmann, R. and Philippsen, P. (1994). New heterologous modules for classical or PCR-based gene disruptions in *Saccharomyces cerevisiae*. *Yeast* **10**, 1793–1808.
- Winston, F., Dollard, C. and Ricupero-Hovasse, S. L. (1995). Construction of a set of convenient *Saccharomyces cerevisiae* strains that are isogenic to S288C. *Yeast* **11**, 53–55.